

110V and Solar Cameras

Leasing Return Guide

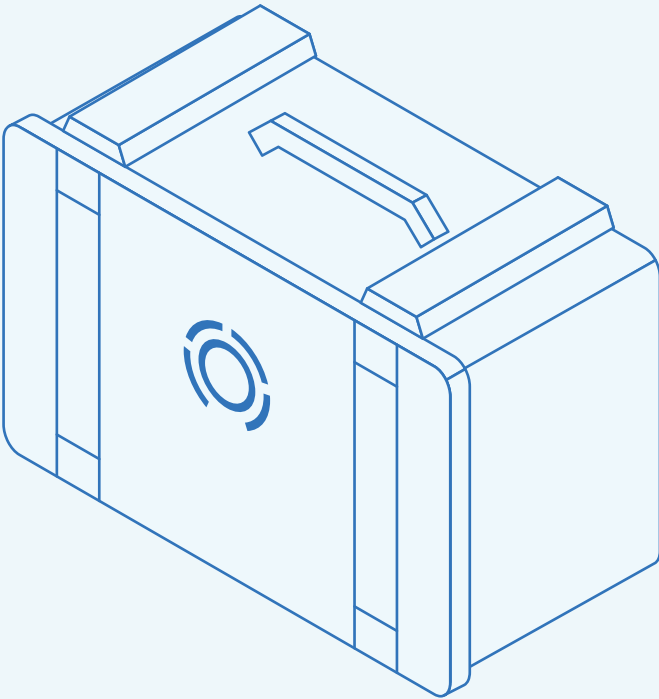

Unlimited Support

Thank you for choosing TrueLook's Leasing Program for your jobsite's documentation needs! When your lease ends, please use the below information to contact our Leasing Department.

Email: leasing@truelook.com

Warning: Please note that all equipment is your responsibility until it returns to our warehouse.

Cameras with a Control Box

4K IR Fixed



2K IR PTZ

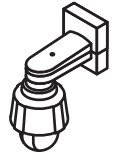

4K IR PTZ

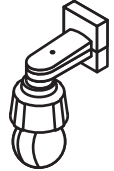

TrueDeter PTZ

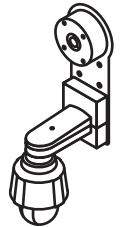

TrueDeter Fixed

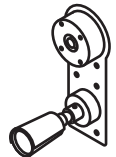

Preparation

Step 1 If your camera is **solar-powered**, remove the connector with a silver collar from the control box by hand-twisting the collar counter-clockwise.



If your camera is powered by **110V**, unplug the 110V cable from the control box. Repeat to remove the other end of the power cable from its power source.

Step 2 Disconnect the camera system from the control box by twisting the protective cap(s) on the camera connector(s) counter-clockwise. Remove the connector(s) by pressing the clip to release the connector(s), then twist the hanging protective cap(s) onto the device input(s).

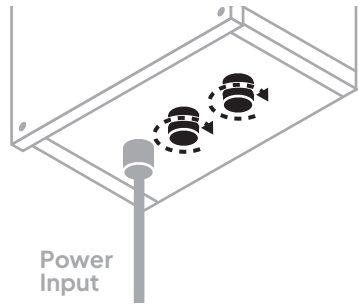
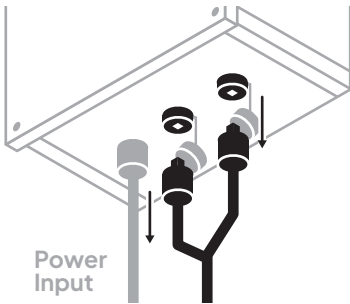

Step 3 Remove the camera system from its mounting location. If it was pole mounted using steel straps, safely dispose of straps, being aware of sharp edges.

Preparation

Step 4 Thoroughly clean off all equipment using a microfiber cloth. All equipment must be completely dry before placing inside the hard case to prevent water damage.

Step 5 Place the lens cap on (not applicable to PTZ cameras).

Step 6 Wrap the camera and control box separately in bubble wrap. Secure bubble wrap with tape.

Step 7 Pack into the hard case and add extra packing material to avoid shifting.

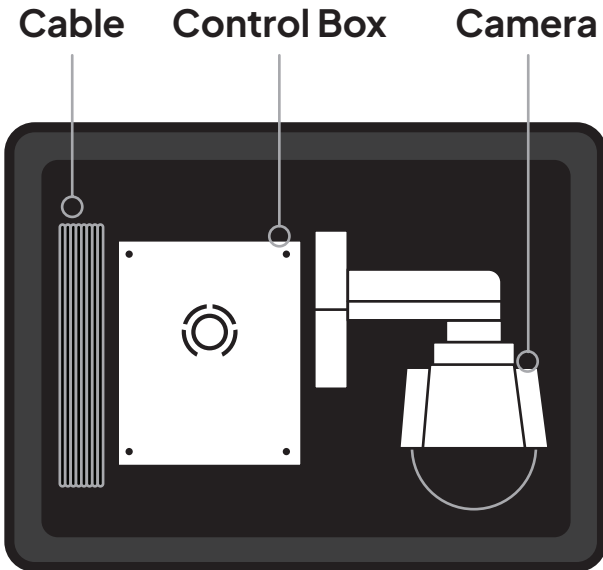

Cameras without a Control Box

Interior Multi-Camera

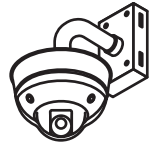

Step 1 Remove the connector with a silver collar from the camera by hand-twisting the collar counter-clockwise.

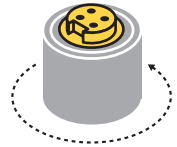

Step 2 Remove the camera system from its mounting location. If it was pole mounted using steel straps, safely dispose of straps, being aware of sharp edges.

Step 3 Thoroughly clean off all equipment using a microfiber cloth. All equipment must be completely dry before placing inside the hard case to prevent water damage while in transit.

Preparation

Step 4 Pack into the hard case.

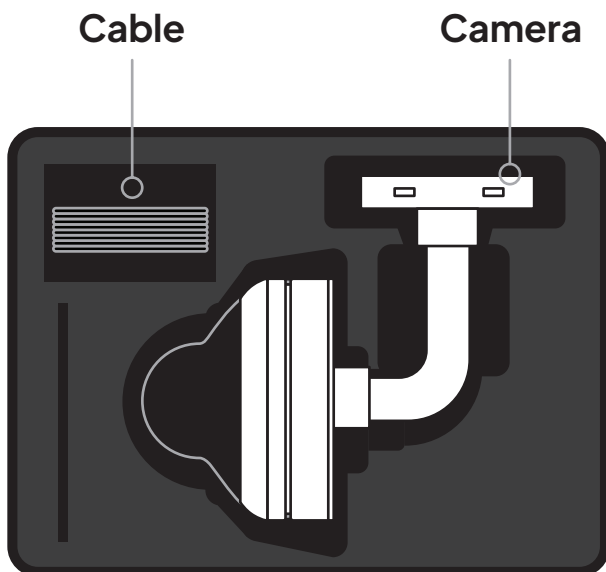

Shipping the Equipment

110V Cameras

Step 1 Email a picture of the open packed case to leasing@truelook.com. Our team will confirm if it's ready to ship or provide suggestions for more secure shipping.

Step 2 Once the case is approved to ship, close the hard case and ensure all latches are properly shut.

Step 3 Place your shipping label into a luggage tag (not included) and attach it to the hard case handle.

It should be shipped to:

TrueLook, Inc.
Attn: Leasing Department
305 Junia Ave
Winston-Salem, NC 27127

Step 4 Email the shipment tracking number to leasing@truelook.com.

Solar Cameras

Follow the instructions in the **Solar Equipment Leasing Return Guide** to secure the hard case onto the pallet and ship the equipment.